

40V HIGH CURRENT LOW LEAKAGE SCHOTTKY DIODE
Product Summary

V_{RRM} (V)	I_o (A)	V_F Max (V) @ +25°C	I_R Max (μ A) @ 30V +25°C
40	2	0.54	40

Features and Benefits

- Low Equivalent on Resistance
- Extremely Low Leakage
- Low V_F , Fast Switching Schottky
- Package Thermally Rated to +150°C
- **Totally Lead-Free & Fully RoHS Compliant (Notes 1 & 2)**
- **Halogen and Antimony Free. "Green" Device (Note 3)**
- **Qualified to AEC-Q101 Standards for High Reliability**

Description and Applications

A surface mount Schottky Barrier Diode featuring low forward voltage drop suitable for high frequency rectification and reverse voltage protection.

- DC – DC Converters
- Strobes
- Mobile Phones
- Charging Circuits
- Motor Control

Mechanical Data

- Case: SOT26
- Case Material: Molded Plastic, "Green" Molding Compound; UL Flammability Classification Rating 94V-0
- Moisture Sensitivity: Level 1 per J-STD-020
- Terminals: Matte Tin Finish Annealed over Copper Leadframe; (Lead-Free Plating) Solderable per MIL-STD-202, Method 208
- Weight: 0.016 grams (Approximate)

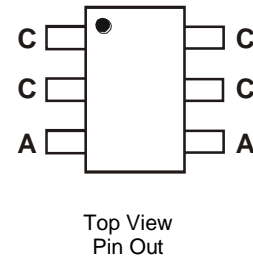
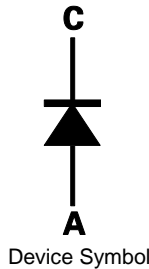
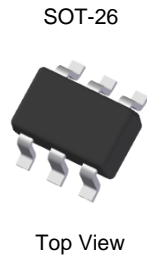

Ordering Information

Device	Packaging	Shipping
ZLLS2000TA	SOT26	3,000/Tape & Reel
ZLLS2000TC	SOT26	10,000/Tape & Reel

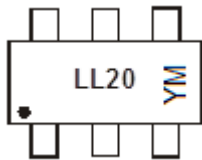
- Notes:
1. No purposely added lead. Fully EU Directive 2002/95/EC (RoHS) & 2011/65/EU (RoHS 2) compliant.
 2. See http://www.diodes.com/quality/lead_free.html for more information about Diodes Incorporated's definitions of Halogen- and Antimony-free, "Green" and Lead-free.
 3. Halogen- and Antimony-free "Green" products are defined as those which contain <900ppm bromine, <900ppm chlorine (<1500ppm total Br + Cl) and <1000ppm antimony compounds.
 4. For Packaging Details, go to our website at <http://www.diodes.com/products/packages.html>.

Marking Information

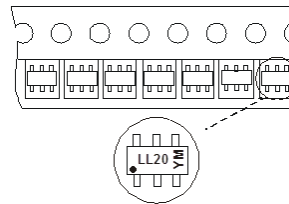
LL20 = Product Type Marking Code
 YM = Date Code Marking
 Y or \bar{Y} = Year (ex: D = 2016)
 M or \bar{M} = Month (ex: 9 = September)

Date Code Key

Year	2016	2017	2018	2019	2020	2021	2022	2023	2024	2025	2026	
Code	D	E	F	G	H	I	J	K	L	M	N	
Month	Jan	Feb	Mar	Apr	May	Jun	Jul	Aug	Sep	Oct	Nov	Dec
Code	1	2	3	4	5	6	7	8	9	O	N	D

Maximum Ratings (@T_A = +25°C, unless otherwise specified.)

Characteristic	Symbol	Value	Unit
Continuous Reverse Voltage	V _{RRM}	40	V
Forward Current	I _F	2.2	A
Peak Repetitive Forward Current Rectangular Pulse Duty Cycle	I _{FPK}	3.55	A
Non Repetitive Forward Current	I _{FSM}	t ≤ 100μs	36
		t ≤ 10ms	12

Thermal Characteristics

Characteristic	Symbol	Value	Unit
Power Dissipation @T _A = +25°C		-	-
Single Die Continuous	P _D	1.1	W
Single Die Measured at t < 5 secs		1.71	W
Junction to Ambient (Note 5)	R _{θJA}	113	°C/W
Junction to Ambient (Note 6)	R _{θJA}	73	°C/W
Storage Temperature Range	T _{STG}	-55 to +150	°C
Junction Temperature	T _J	+150	°C

Notes: 5. For a device surface mounted on 25mm x 25mm FR-4 PCB with high coverage of single sided 1oz copper, in still air conditions.
6. For a device mounted on FR-B PCB measured at t < 5secs.

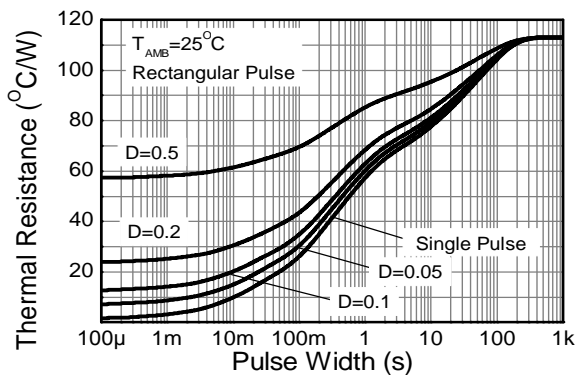
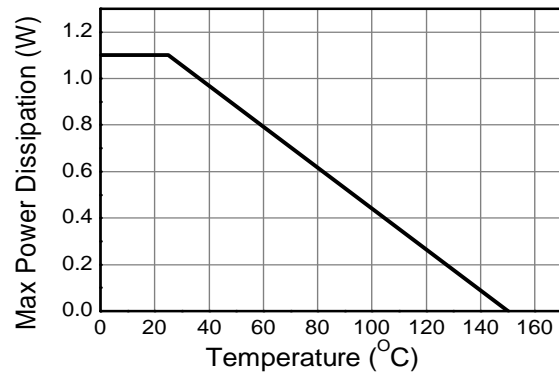
Transient Thermal Impedance

Derating Curve
Electrical Characteristics (@T_A = +25°C, unless otherwise specified.)

Characteristic	Symbol	Min	Typ	Max	Unit	Test Condition
Reverse Breakdown Voltage	V _{(BR)R}	40	-	-	V	I _R = 1mA
Forward Voltage (Note 7)	V _F	-	285	-	mV	I _F = 50mA
		-	305	-		I _F = 100mA
		-	335	-		I _F = 250mA
		-	365	390		I _F = 500mA
		-	403	430		I _F = 1A
		-	433	490		I _F = 1.5A
		-	461	540		I _F = 2A
		-	509	600		I _F = 3A
Reverse Current	I _R	-	10	40	μA	V _R = 30V
		-	0.6	-	mA	V _R = 30V, T _A = +85°C
Diode Capacitance	C _D	-	65	-	pF	f = 1MHz, V _R = 30V
Reverse Recovery Time	t _{RR}	-	6	-	ns	Switched from I _F = 500mA to V _R = 5.5V
Reverse Recovery Charge	Q _{RR}	-	685	-	nC	Measured @ I _R 50mA, di/dt = 500mA/ns. R _{SOURCE} = 6Ω; R _{LOAD} = 10Ω

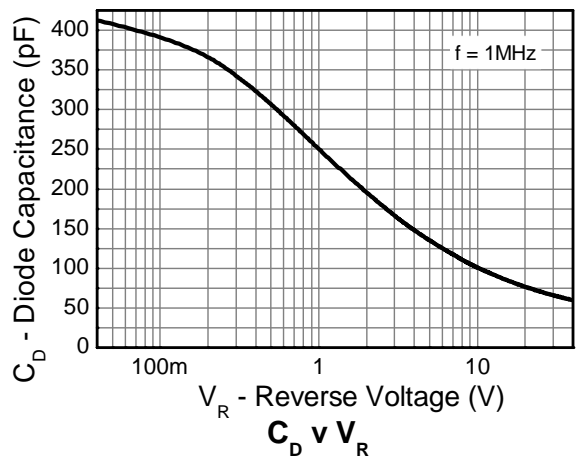
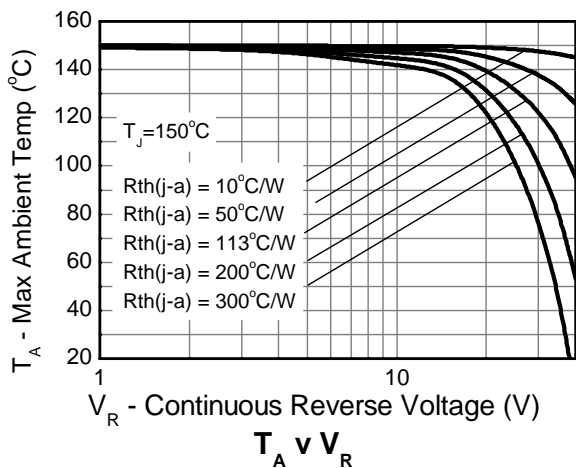
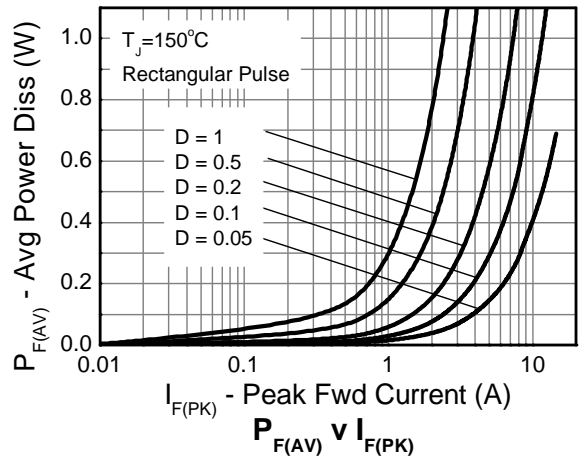
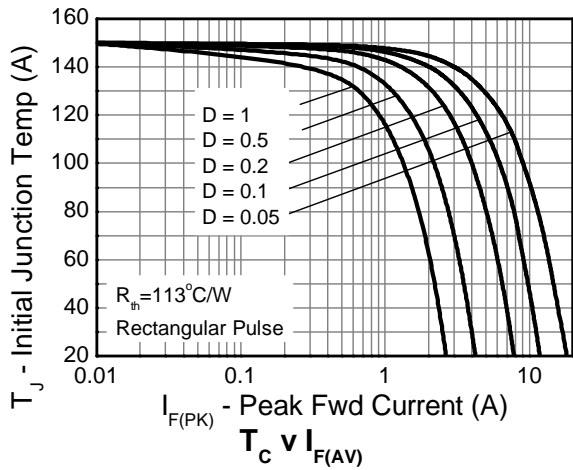
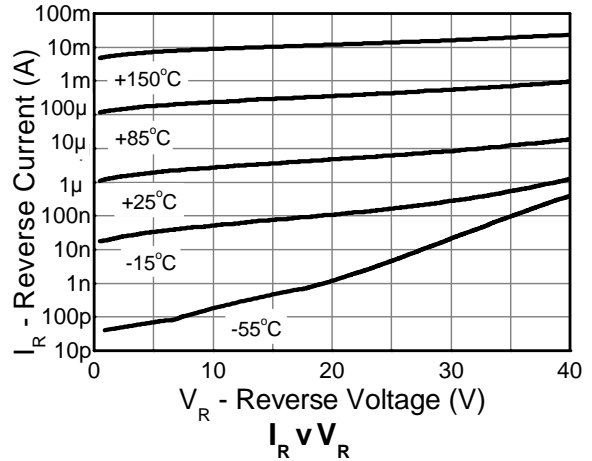
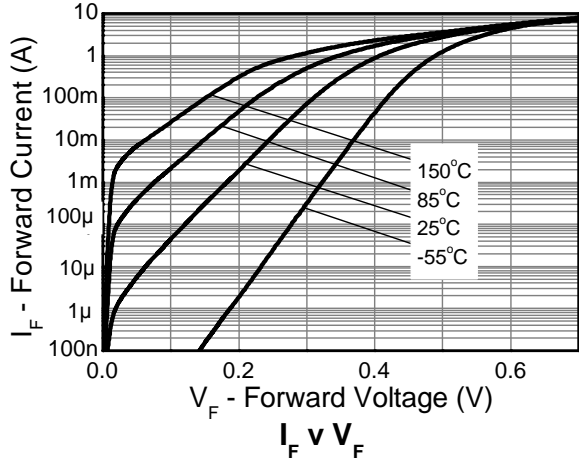
Note: 7. Measured under pulsed conditions. Pulse width = 300μs. Duty cycle < 2%.



Package Outline Dimensions

Please see <http://www.diodes.com/package-outlines.html> for the latest version.

SOT26

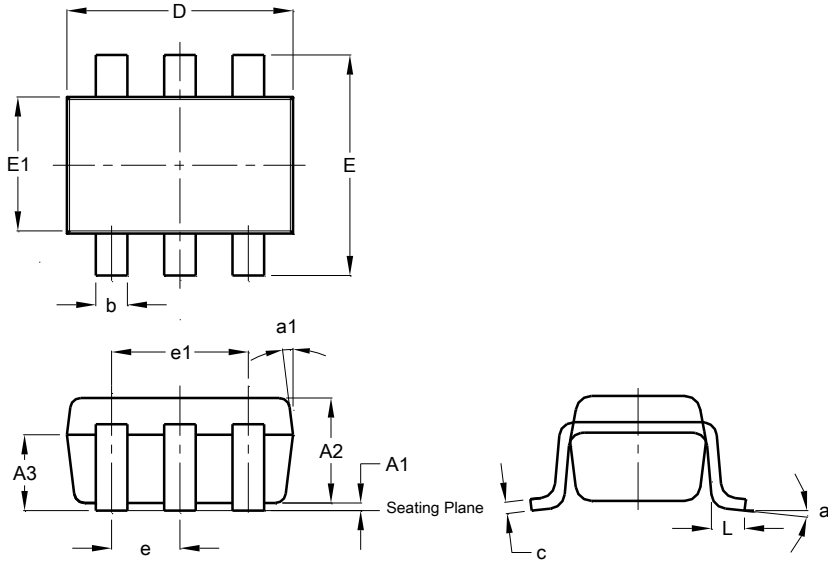

SOT26			
Dim	Min	Max	Typ
A1	0.013	0.10	0.05
A2	1.00	1.30	1.10
A3	0.70	0.80	0.75
b	0.35	0.50	0.38
c	0.10	0.20	0.15
D	2.90	3.10	3.00
e	-	-	0.95
e1	-	-	1.90
E	2.70	3.00	2.80
E1	1.50	1.70	1.60
L	0.35	0.55	0.40
a	-	-	8°
a1	-	-	7°
All Dimensions in mm			

Suggested Pad Layout

Please see <http://www.diodes.com/package-outlines.html> for the latest version.

SOT26

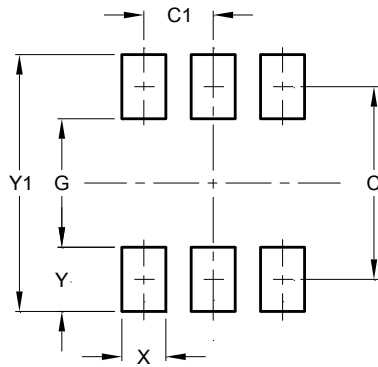

Dimensions	Value (in mm)
C	2.40
C1	0.95
G	1.60
X	0.55
Y	0.80
Y1	3.20

IMPORTANT NOTICE

DIODES INCORPORATED MAKES NO WARRANTY OF ANY KIND, EXPRESS OR IMPLIED, WITH REGARDS TO THIS DOCUMENT, INCLUDING, BUT NOT LIMITED TO, THE IMPLIED WARRANTIES OF MERCHANTABILITY AND FITNESS FOR A PARTICULAR PURPOSE (AND THEIR EQUIVALENTS UNDER THE LAWS OF ANY JURISDICTION).

Diodes Incorporated and its subsidiaries reserve the right to make modifications, enhancements, improvements, corrections or other changes without further notice to this document and any product described herein. Diodes Incorporated does not assume any liability arising out of the application or use of this document or any product described herein; neither does Diodes Incorporated convey any license under its patent or trademark rights, nor the rights of others. Any Customer or user of this document or products described herein in such applications shall assume all risks of such use and will agree to hold Diodes Incorporated and all the companies whose products are represented on Diodes Incorporated website, harmless against all damages.

Diodes Incorporated does not warrant or accept any liability whatsoever in respect of any products purchased through unauthorized sales channel. Should Customers purchase or use Diodes Incorporated products for any unintended or unauthorized application, Customers shall indemnify and hold Diodes Incorporated and its representatives harmless against all claims, damages, expenses, and attorney fees arising out of, directly or indirectly, any claim of personal injury or death associated with such unintended or unauthorized application.

Products described herein may be covered by one or more United States, international or foreign patents pending. Product names and markings noted herein may also be covered by one or more United States, international or foreign trademarks.

This document is written in English but may be translated into multiple languages for reference. Only the English version of this document is the final and determinative format released by Diodes Incorporated.

LIFE SUPPORT

Diodes Incorporated products are specifically not authorized for use as critical components in life support devices or systems without the express written approval of the Chief Executive Officer of Diodes Incorporated. As used herein:

A. Life support devices or systems are devices or systems which:

1. are intended to implant into the body, or
2. support or sustain life and whose failure to perform when properly used in accordance with instructions for use provided in the labeling can be reasonably expected to result in significant injury to the user.

B. A critical component is any component in a life support device or system whose failure to perform can be reasonably expected to cause the failure of the life support device or to affect its safety or effectiveness.

Customers represent that they have all necessary expertise in the safety and regulatory ramifications of their life support devices or systems, and acknowledge and agree that they are solely responsible for all legal, regulatory and safety-related requirements concerning their products and any use of Diodes Incorporated products in such safety-critical, life support devices or systems, notwithstanding any devices- or systems-related information or support that may be provided by Diodes Incorporated. Further, Customers must fully indemnify Diodes Incorporated and its representatives against any damages arising out of the use of Diodes Incorporated products in such safety-critical, life support devices or systems.

Copyright © 2016, Diodes Incorporated

www.diodes.com